

# COMBOCADE™

TYPE I AND TYPE II BARRICADE

Steel leg barricade  
with plastic boards



- Combocade's replaceable components save you money!
  - boards can be replaced
  - legs can be replaced or repaired
- Standard 45" steel legs, 14 gauge thickness
  - galvanized finish for corrosion protection
- Plastic boards last longer than wood!
  - injection molded boards are strong and dense, reinforced with our "diamond" design
  - boards will not bend, warp, crack, splinter, or peel
  - available in 24"W x 12"H, 8"H, or 6"H
- No drilling - save labor!
  - bolt holes are molded into the plastic boards, making board replacement quick and easy
- NCHRP-350 Accepted, Meets MUTCD Standards



Purchase barricades fully assembled or as component parts. Names can be stenciled on the boards for identification

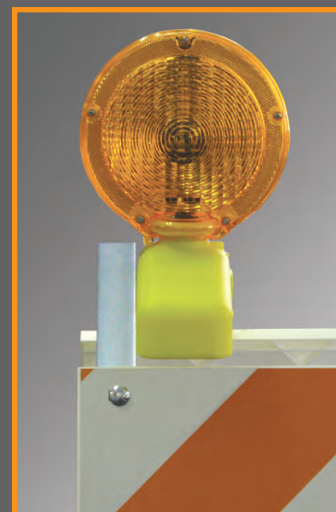

Leg hinge holes accept  
1/2" light mounting bolt

**PLASTICADE®**

[www.plasticade.com](http://www.plasticade.com)

# COMBOCADE™

## TYPE I & TYPE II BARRICADE

Front View

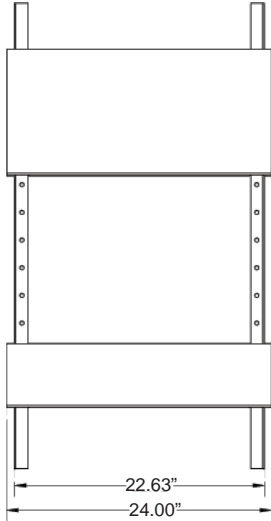

Side View

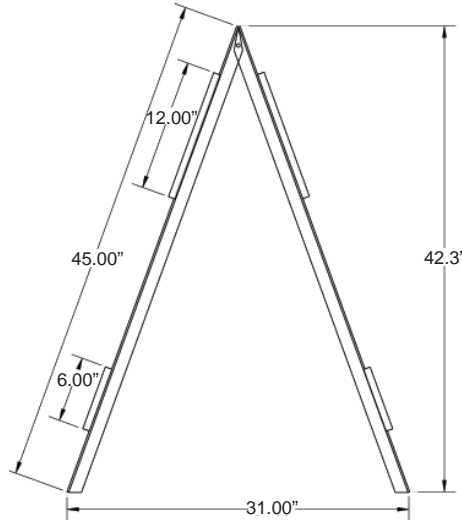

Specs	
Dimensions	45"H x 24"W x 2 1/2"D
Leg Composition	Roll Formed Steel, Galvanized, white powder coated by special order
Leg Weight	2.2 lbs.
Leg Thickness	14 gauge - 1 1/4"
Board Composition	High Density Polyethylene
Board Sizes	12"H x 24"W - 1.6 lbs. 8"H x 24"W - 1.4 lbs. 6"H x 24"W - 1 lb.
Board Thickness	5/8" D
Board Color	White
Reflective Sheeting	Available in all grades in white and orange stripes

24"W x 12"H Board

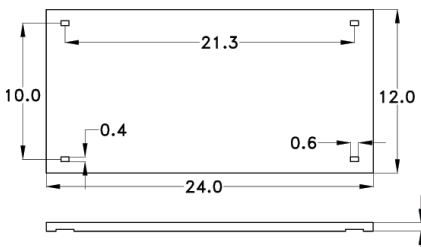

24"W x 8"H Board

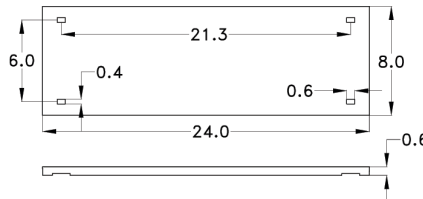

24"W x 6"H Board

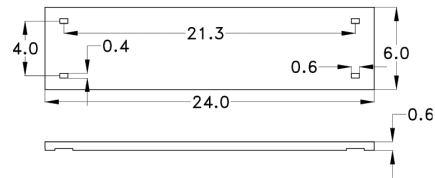

Back of Board

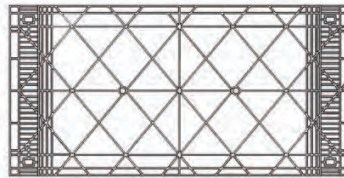

**PLASTICADE®**

7700 N. Austin Avenue  
Skokie, IL 60077  
phone (800) 772-0355  
fax (847) 966-8074

[www.plasticade.com](http://www.plasticade.com)



MADE IN THE USA